

Report: Summary of Findings on the April 17, 2009 Death of Bassem Ibrahim Abu Rahma, Bil'in

Page 1: Introduction

A summary of findings

Page 2: Launch Angle Visualization

A reconstruction of the path of the projectile and quantification of distance traveled in relation to launch angle

Page 3: Video Analysis

An analysis of key frames of video footage to determine the path of the projectile

Page 4-5: Path Reconstruction

An analysis and reconstruction of possible trajectories

Page 6-8: Technical Annex

An explanation of the tools and methodologies applied in the report

Prepared by:

Goldsmiths' Center for Research Architecture and Situ Studio

April 23, 2010

Report: Summary of Findings on the April 17, 2009 Death of Bassem Ibrahim Abu Rahma, Bil'In

The following pages outline a report that was initiated at the request of Attorney Michael Sfar and the Israeli Human Rights organization B'Tselem to reconstruct the events of the April 17, 2009 protest at Bil'in in which a protestor, Bassem Ibrahim Abu Rahma, was struck and killed by a tear gas grenade. Mr. Abu Rahma was standing on the eastern side of the separation barrier when the munition struck him in the chest causing massive internal bleeding which led to his death. The following report focuses on establishing the probable angle at which the munition that killed Mr. Abu Rahma was discharged and addresses assertions made by the Israeli Defense Forces that the round in question struck a wire in the fence causing it to change direction and hit the victim.

Publicly available specifications for the 40mm tear gas grenade (Model 4431 Powder Barricade Penetrating, CS manufactured by the Pennsylvania based Combined Systems Inc.) were used for the ballistic analysis. In addition to the munition's technical specifications, the analysis also incorporates video footage from three handheld digital cameras that recorded the event. These videos were used to determine the position of the victim at the site as well as to verify the trajectory of the munition as it was fired from across the barrier. In a single frame of one of the videos, the munition is visible fractions of a second before striking the victim standing less than a meter from the videographer.

After analyzing the video footage and conducting a series of calculations at various launch angles it appears highly improbable that the lethal round was discharged at 60 degrees or above (the minimum angle specified in The Open Fire Regulations for indirect fire) 1. Based on our analysis either one of two scenarios occurred2 :

Scenario A: Direct Hit

If the lethal round struck Mr. Abu Rahma directly without deflecting off of any part of the fence, it would have had to be fired at a launch angle of -1 to 1 degrees.

Scenario B: Fence Deflection

If the lethal round first hit a wire in the fence, changed direction, and then struck Mr. Abu Rahma it would have had to be fired at -1 to 5 degrees. If shot an angle over 5 degrees the round would have passed over the fence. To hit the fence when firing at sixty degrees the soldier would have had to have been standing no more than two meters from the fence. Based on our analysis of positions of soldiers apparent throughout the video footage we have concluded that the distance between the soldiers and the fence exceeded 2 meters.

1. Per the April 21, 2009 letter addressed to Military Advocate-General Avichai Mandelblit, from B'tselem Executive Director Jessica Montell.

2. Based on the footage available, an assumption has been made that the soldier and victim were standing 32-48 meters apart.

LAUNCH ANGLE VISUALIZATION

A series of diagrams have been constructed which illustrate the ballistic path of a Combined Systems Inc. model 4431 CS Powder Barricade Penetrating projectile when fired from a series of launch angles. The calculations employed for these diagrams applied available information for topographic conditions of the site as well as the relative positions of the IDF soldier and victim. The position of the victim can be established within a few meters based on the available video footage. An assumption was made regarding the position of the IDF soldier based also on video footage. For all launch angles above 5 degrees, the path of the munition travels above the position where Mr. Abu Rahma was standing when struck. Given the position of the victim 32 – 48 meters from the soldiers firing the CS rounds, a launch angle of -1 to 5 degrees appears to be most consistent with the injury sustained.

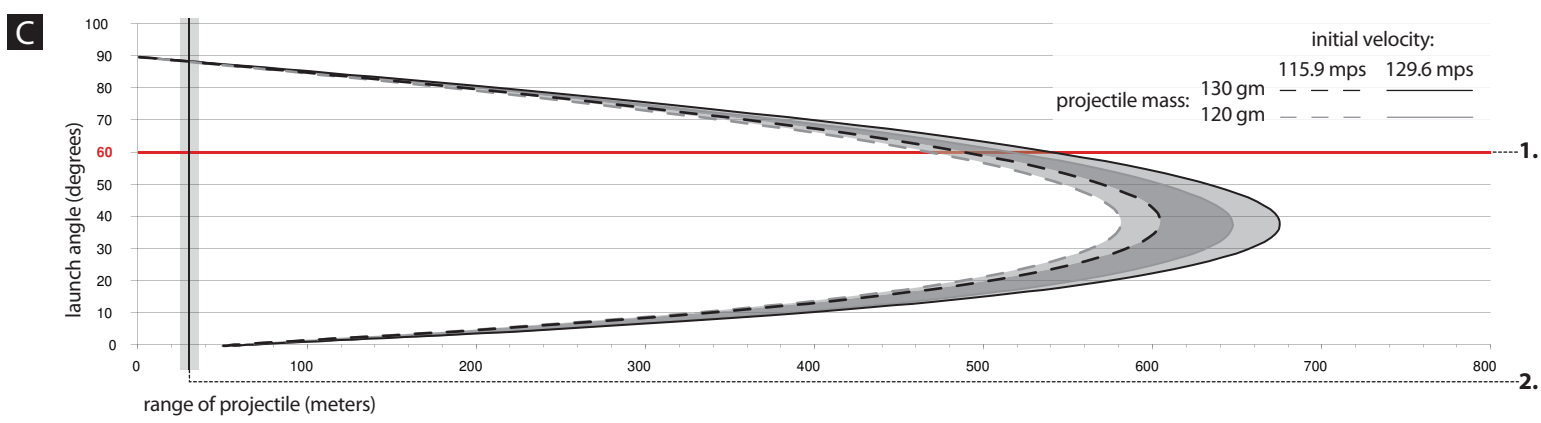
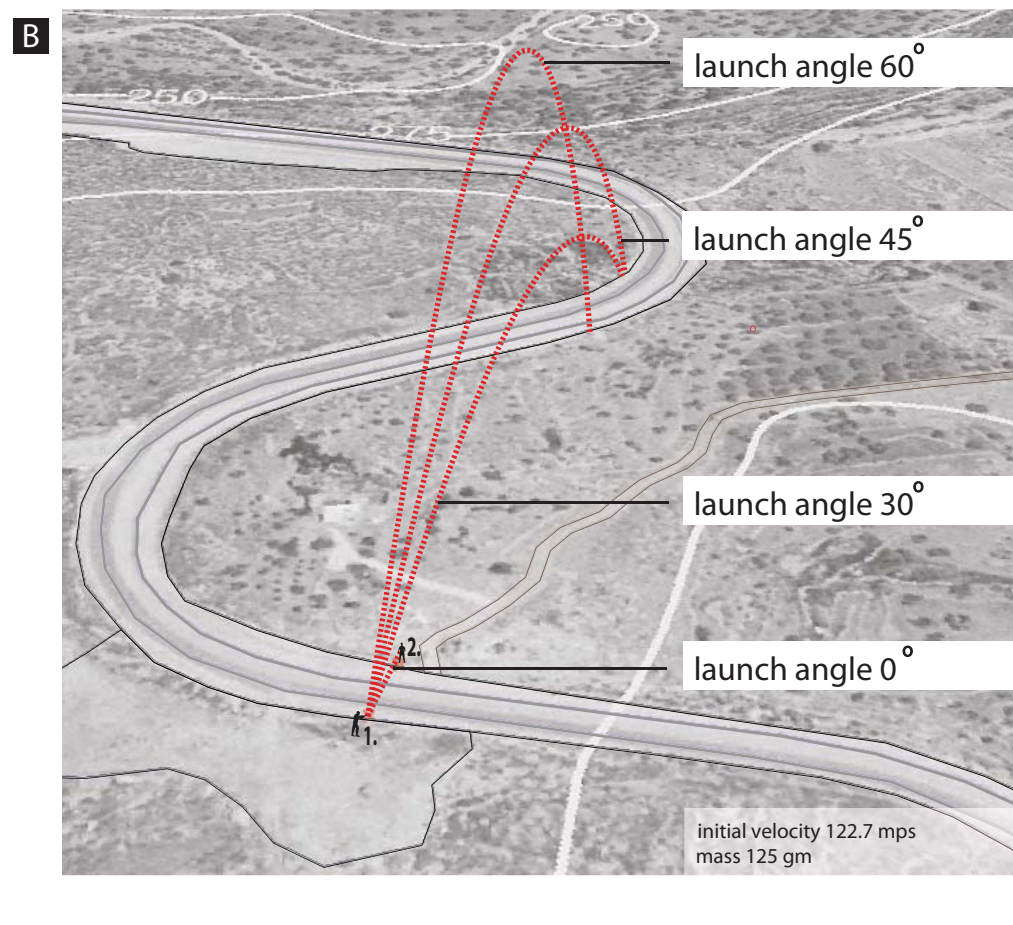
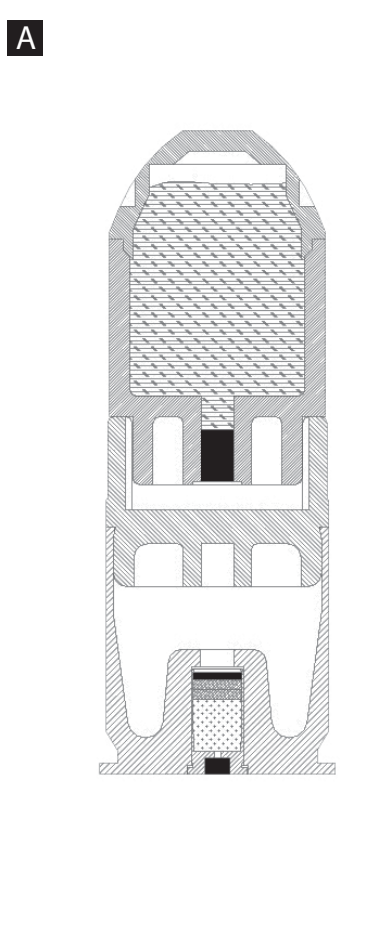

A) Combined Systems, Inc., MODEL 4431 40mm CS Powder Barricade Projectile.

B) Trajectories of variable launch angles, with locations of 1. IDF soldier and 2. Bassem. An initial velocity of 122.7 mps and weight of 125 g were used. These figures represent a median of CSIs published ranges.

C) Graph of projectile range for given launch angle, showing 1. the minimum legal launch angle of 60 degrees and 2. the estimated distance between point of launch and point of injury as 40 meters plus or minus 20 percent, or a range of 32-48 meters. Distance figures assume a 1 meter drop in elevation prior to measurement.

VIDEO ANALYSIS

Video taken by three separate people captured the event of Mr. Rahma's death. In the moments directly preceding the impact of the munition, David Reeb, one of the videographers, is standing within a meter from Mr. Abu Rahma. At approximately 5:38 Reeb's video camera is directed to the northwest, capturing footage of IDF soldiers on the opposite side of the separation barrier. At 5:44.07 of the video a projectile passes through the frame of view and, fractions of a second later, strikes Mr. Abu Rahma who is standing directly to Reeb's right. The diagrams below analyze this footage in relation to the trajectories produced from the ballistic analysis. The passage of the munition seen in Reeb's field of view supports the conclusion that the weapon discharged at a low launch angle.

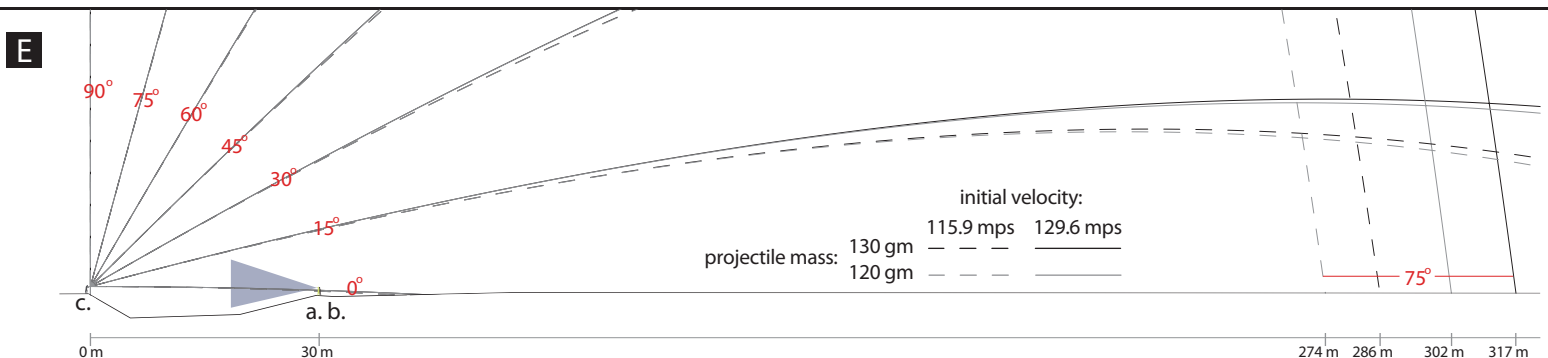
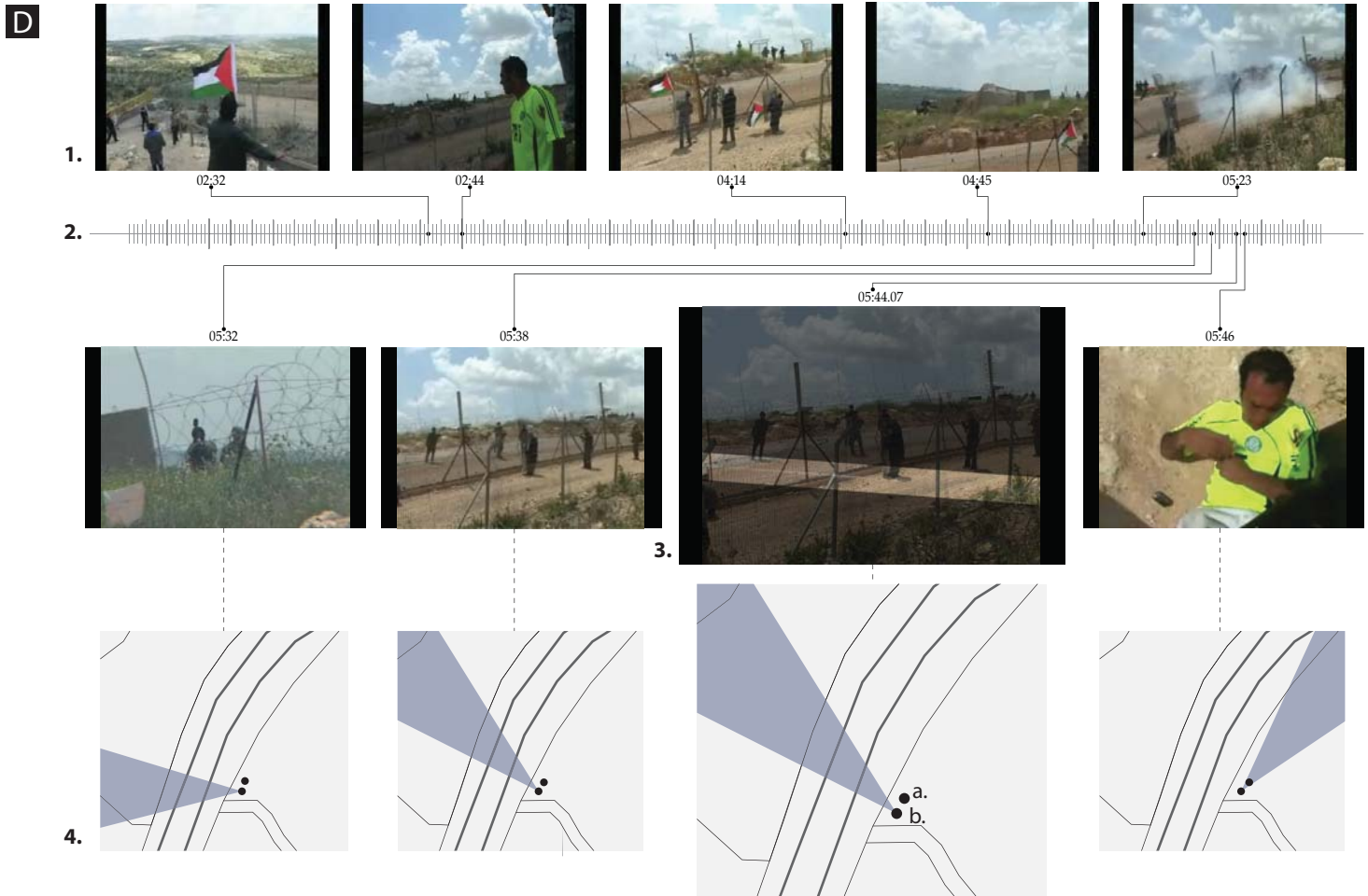

D) Video stills from one video witness, showing 1. significant moments leading up to point of injury along 2. a timeline. 3. The munition in its projectile path appears in the field of view at 5:44.07 passing from upper left to lower right of the frame. This portion of the frame is highlighted here. 4. Plan diagrams locate a. Bassem as well as the field of view recorded by b. video witness Reeb.

E) Elevation of relative positioning of c. IDF soldier, a. Bassem, and b. video witness, capturing projectile path in field of view.

PATH RECONSTRUCTION

A single frame in David Reeb’s video footage that captured the flight of the lethal cartridge is used to reconstruct the path of the munition in a virtual model of the scene. After precisely locating the position of the camera and Abu Rahma, the line illustrating the trajectory is extracted back into space to form a plane bounded by Reeb’s camera and the edge of the video frame. This virtual plane defines all possible flight paths converging to Abu Rahma. When extended outward beyond the separation barrier, a zone of probable firing position is determined. The intersection of this plane with the tall wire fence defines a zone in which a shot could have ricocheted in order to achieve the recorded trajectory. Based on the known positions of the IDF soldiers at the time, the maximum angle of fire to achieve this result is 5°.

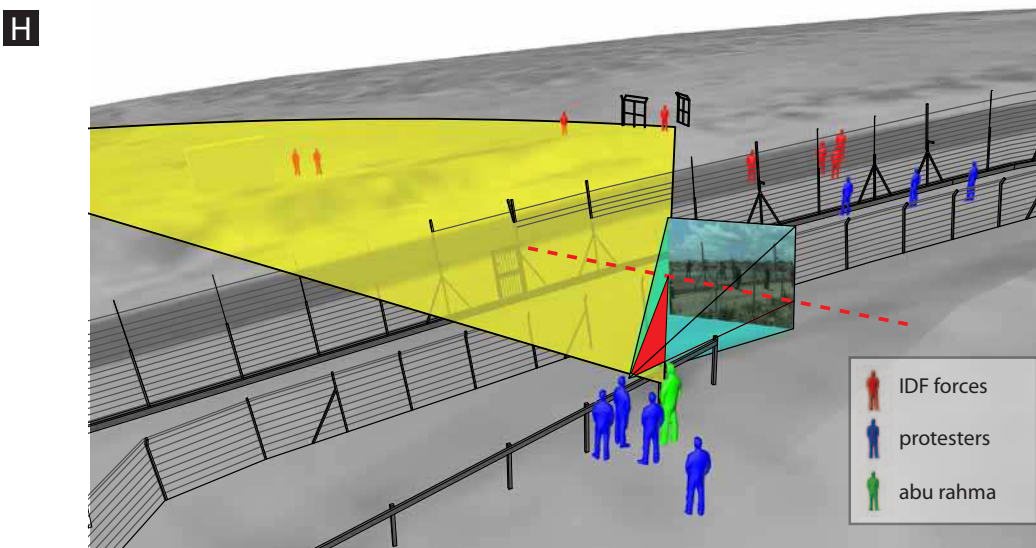
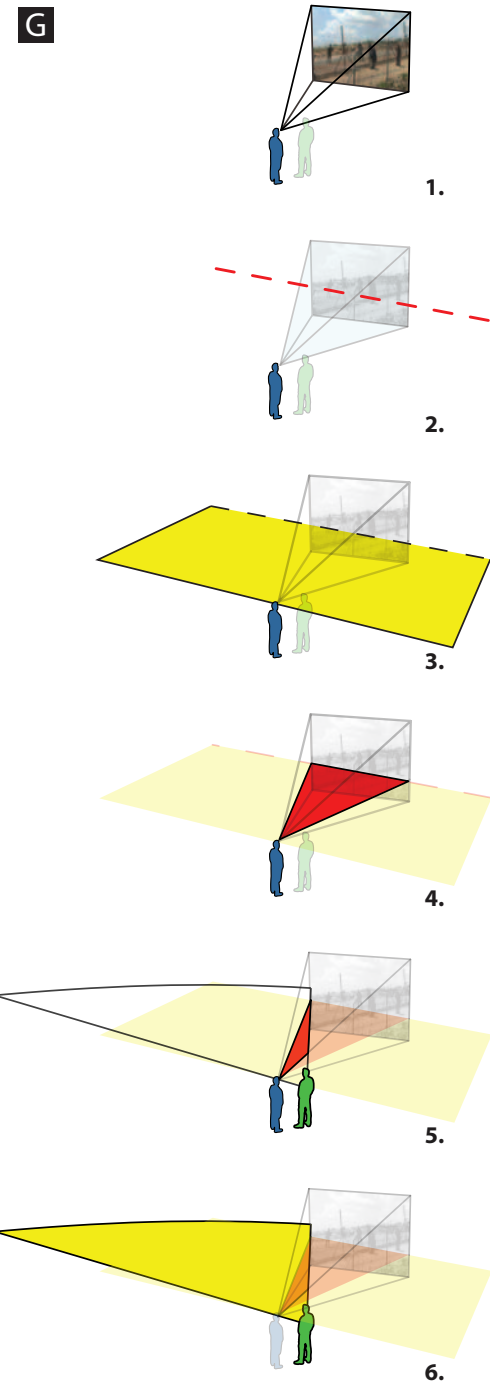

F) Video still at time 5:44.07 from David Reeb’s video footage showing the path of the lethal projectile passing from upper left to lower right of the frame.
 H) Series of diagrams showing how plane of possible trajectories was established: 1) Position of Videographer David Reeb. 2) Red dashed line highlighting path of lethal projectile across video still. 3) Path of projectile extended into space at height of camera, defining a virtual plane in yellow. 4) Red triangular plane highlights section of yellow projectile plane that intersects with field of view of the camera. 5) Projectile plane intersected by lines converging on Abu Rahma’s torso limited by David Reeb to the south and the edge of the video frame to the north. 6) Resulting yellow arc shows possible firing positions of lethal projectile by IDF Soldier.
 G) Image from the 3D virtual model reconstruction of the scene at the moment of the shooting. The intersections of the virtual trajectory plane with the wires of the tall fence are clearly visible.

The height of the yellow virtual plane above the ground on the IDF side of the fence limits the possible locations that the shot could have been fired from. Up to 2m high is the zone from which a direct shot could have been fired. Up to 4m high, as defined by the intersection of the plane with fence 1, is the zone at which a deflection with the fence could have occurred. At the lowest limit of this zone at which a deflection could have occurred, a section is taken to determine the angle of firing of the projectile. This maximum possible firing angle is determined to be 5°.

I

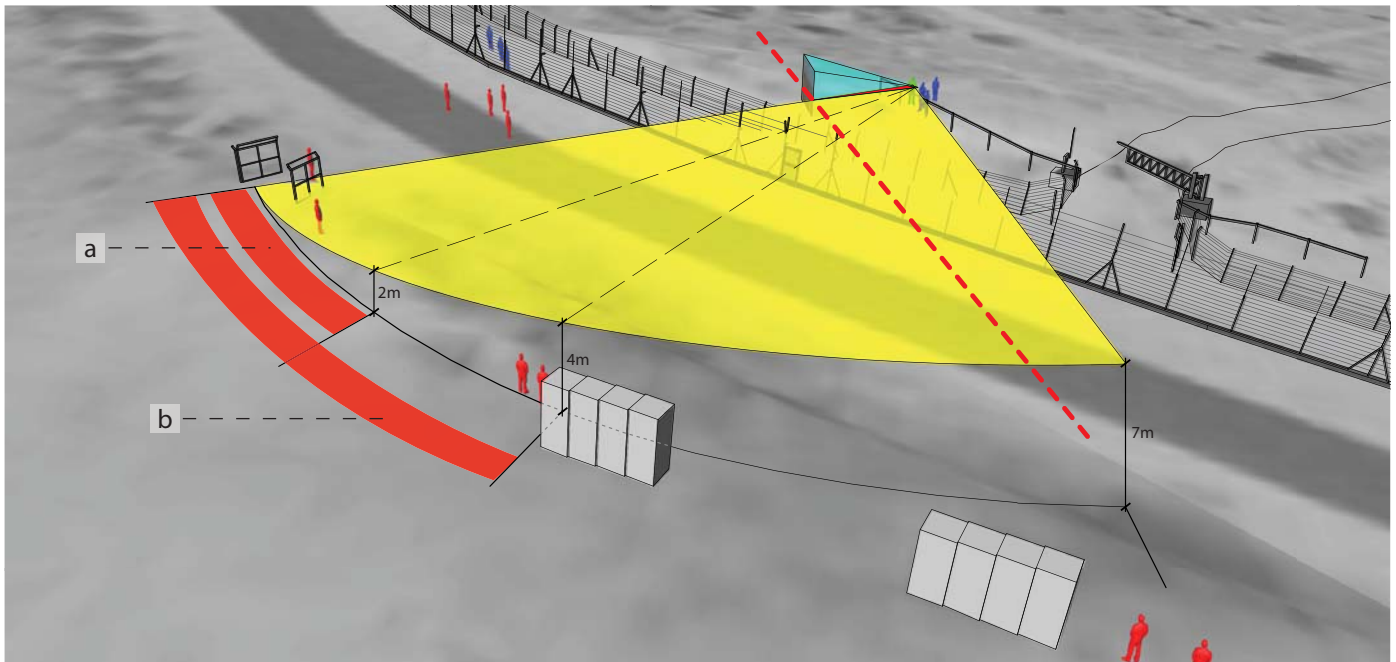

- a zone of direct fire:
-1° to 1° firing angle
- b zone of wire deflection:
-1° to 5° firing angle
- c highest limit of position at
which lethal shot could
have occurred
- d lowest limit of position at
which lethal shot could
have occurred
- e possible trajectory as traced
back from reeb video

J

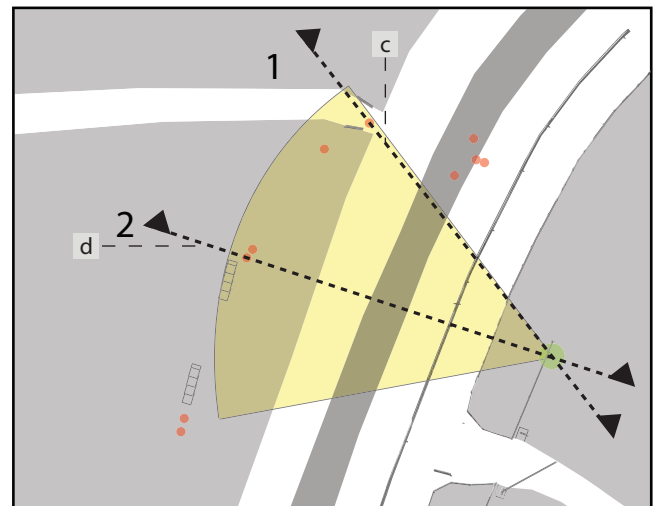

K

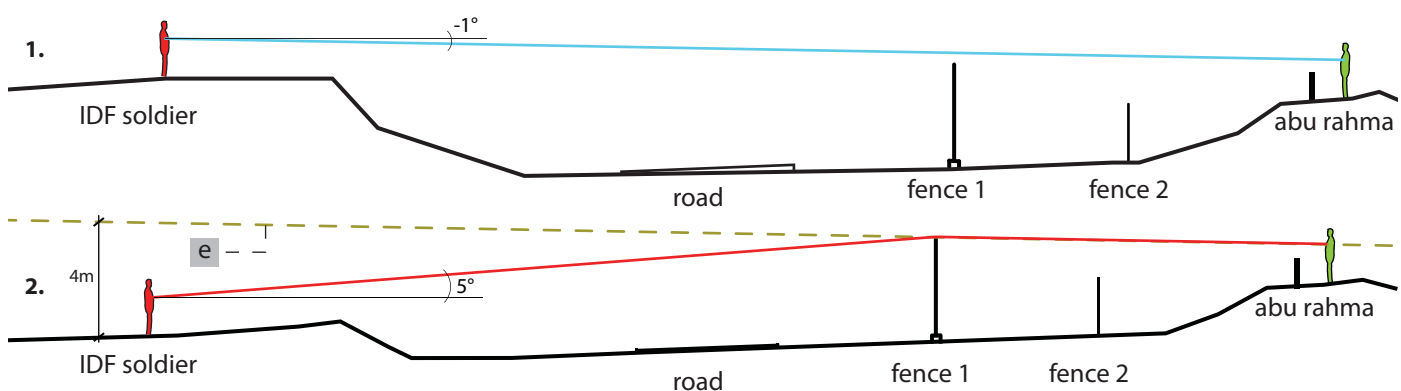

I) Image from the 3D virtual model reconstruction of the scene at the moment of the shooting.

J) The scene is depicted in plan showing where the following sections 1 and 2 are cut.

K) 1. Section drawing of scenario in which munition strikes Abu Rahma directly.

2. Section drawing of scenario in which munition deflects off of fence before striking Abu Rahma.

TECHNICAL ANNEX

A parametric tool was created to allow key variables in the ballistic equation to be easily modified, updated and output in a visual format. The equation for projectile motion was input into Grasshopper - a graphical algorithm editor plug-in used in the digital modeling software, Rhinoceros. The utility of the tool is two-fold. First, it is possible to easily visualize the path of the projectile in a digital model that incorporates the landscape of Bil'In. Secondly, because the tool was designed to allow for modifications of the equation's variables using a series of slider bars, it can easily be adapted to other scenarios in which the behavior of this or other munitions need to be understood.

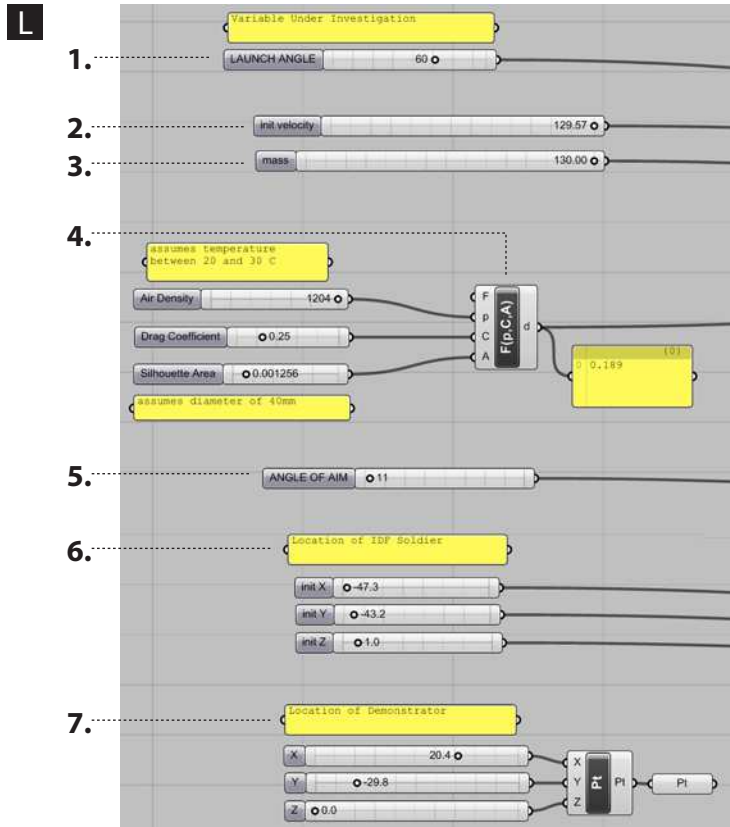

1. Launch Angle:

The critical component of the equation, the variable under investigation.

2. Initial Velocity:

Documentation specifies a range, from 115.85 to 129.57 meters per second.

3. Mass:

The munition has an approximated weight of 130 grams.

4. Drag Force:

The effect of drag force on velocity is a function of air density as well as the projectile's silhouette area and body shape.

5. Aim:

The direction in which the gas canister was launched, determined by the relative position (x,y) of Bassem and IDF soldier.

6. Position of IDF soldier:

The point of launch (x,y,z).



7. Position of Bassem:

The point of injury (x,y,z).

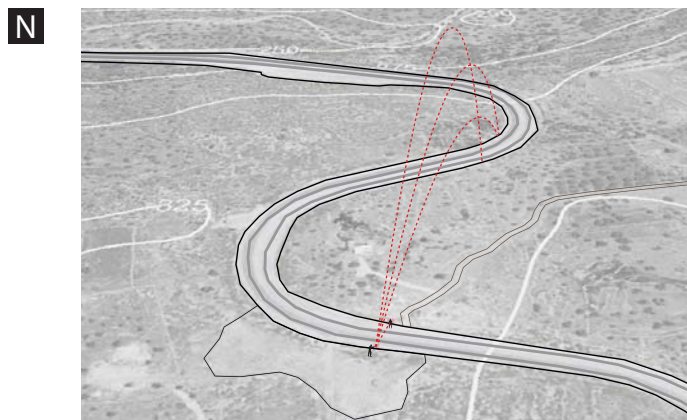
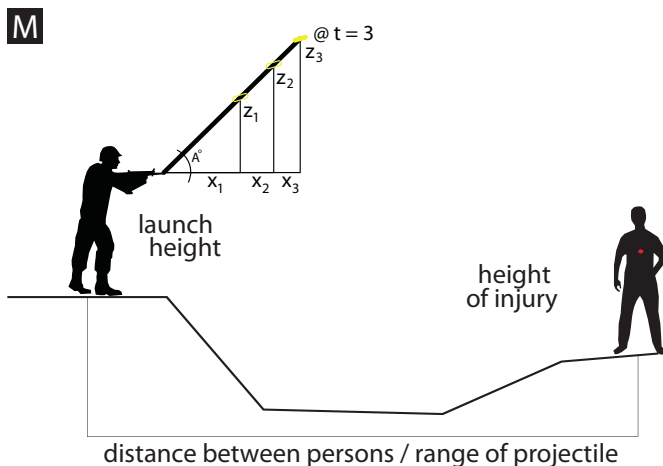

L) Graphic interface of Grasshopper tool, with variable inputs (1.-7.) of the equation modeling projectile path.

M)Diagram of timestepped calculation of projectile path, dependent on initial conditions.

N) Aerial perspective of the landscape at best resolution currently available.

Q

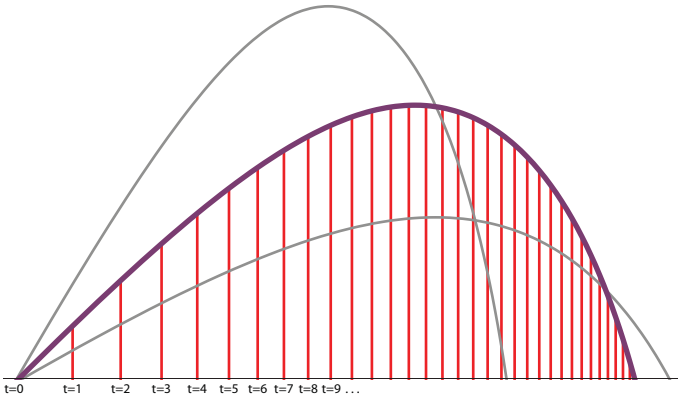

P

Type	Single Projectile
Compatibility	All 40mm M203 & M79 Type Launchers
Discharge Time	Instantaneous, upon impact
Maximum Effective Range	50 yd (45.72m)
Cartridge Material	M212 Plastic Composite
Projectile Material	Plastic Composite
Overall Height	4.8" (12.2 cm)
Overall Weight	133.4 gm
Chemical Weight	17.6 gm
Agent Weight	5.1 gm
Velocity	380-425 fps
Waterproof	Lacquer Coated Primer & Sealed Top

Q

```

Sub RunScript(ByVal A As Double,
ByVal V As Double,
ByVal dt As Double,
ByVal D As Double,
ByVal m As Double,
ByVal T As Double,
ByVal X As Double,
ByVal Z As Double)

Dim dblX As New List(Of Double)
Dim dblZ As New List(Of Double)
Dim dblVx As Double
Dim dblVz As Double
Dim dblAx As Double
Dim dblAz As Double

dblVx = V * math.cos(A)
dblVz = V * math.sin(A)

Dim i As Int32

dblX.Add(x)
dblZ.Add(z)

For i = 0 To T

dblAx = -1 * (D / m) * dblVx * V
dblAz = -9.8 - (D / m) * dblVz * V

dblVx = dblVx + (dblAx * dt)
dblVz = dblVz + (dblAz * dt)

V = math.sqrt((dblVx * dblVx) + (dblVz * dblVz))

x = x + ((dblVx * dt) + (.5 * dblAx * dt * dt))
z = z + ((dblVz * dt) + (.5 * dblAz * dt * dt))

dblX.Add(x)
dblZ.Add(z)

Next

_x = dblX
_z = dblZ

End Sub
    
```

A = launch angle
V = initial velocity
dt = change in time
D = drag
m = mass of canister
T = total time (limit)
X = initial position of canister
Z = initial position of canister

Declare all equation variables:
Split velocity into component Vx and Vz for x and z directions.
Split acceleration into component Ax and Az for x and z directions.

Set Vx equal to Vi * cos(A).
Set Vz equal to Vi * sin(A).

Begin time loop, adding acceleration due to drag and gravity, calculating a new velocity for each time Step, locating new point (x, z) along trajectory curve.

R

The distance traveled (d) of a projectile over a given period of time (dt) is dependent on its:

- launch angle (A)
- initial velocity (V)

Initial velocity is split into its vertical and horizontal components (Vx,Vz) based on the launch angle. Each is calculated independently:

$$V_x = V * \cos(A)$$

$$V_z = V * \sin(A)$$

The distance traveled (dx,dy) over a given interval of time (dt) is based its velocity (Vx,Vz) and its acceleration (Ax,Az). Each direction is calculated independently:

$$d_x = V_x * dt + 0.5 * A_x * dt^2$$

$$d_z = V_z * dt + 0.5 * A_z * dt^2$$

For a realistic path we must take into account air resistance. Acceleration due to air resistance at any time is dependent on velocity (V), drag (D), and mass (m). Component velocity is incorporated to correct for current angle:

$$A_x = -(D/m) * V * V_x$$

$$A_z = -g - V * V_z$$

Drag is pre-calculated using the density of the medium through which the projectile is traveling (p), the object's coefficient of drag (C), and the silhouette area (A) of the projectile

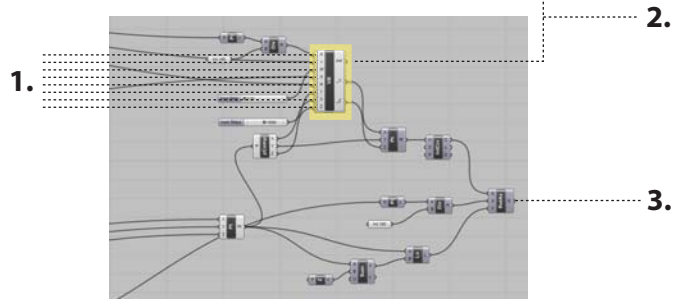
$$D = (p * C * A) / 2$$

Q) Graph of iterative calculations of projectile velocity at any constant interval along its path.
P) Specifications for Combined Systems, Inc., MODEL 4431 40mm CS Powder Barricade Projectile.
Q) Visual Basic script written and plugged into Grasshopper in order to model the projectile path in Rhinoceros. **1.** All variable inputs into the script. **2.** Visual Basic script as written into Grasshopper component. **3.** Final geometry generated by Grasshopper tool.
R) Mathematical explanation of script, computing realistic projectile motion.